

R&S® ZVA110

Broadband Measurements Using the 1 mm External Test Sets

Quick Start Guide

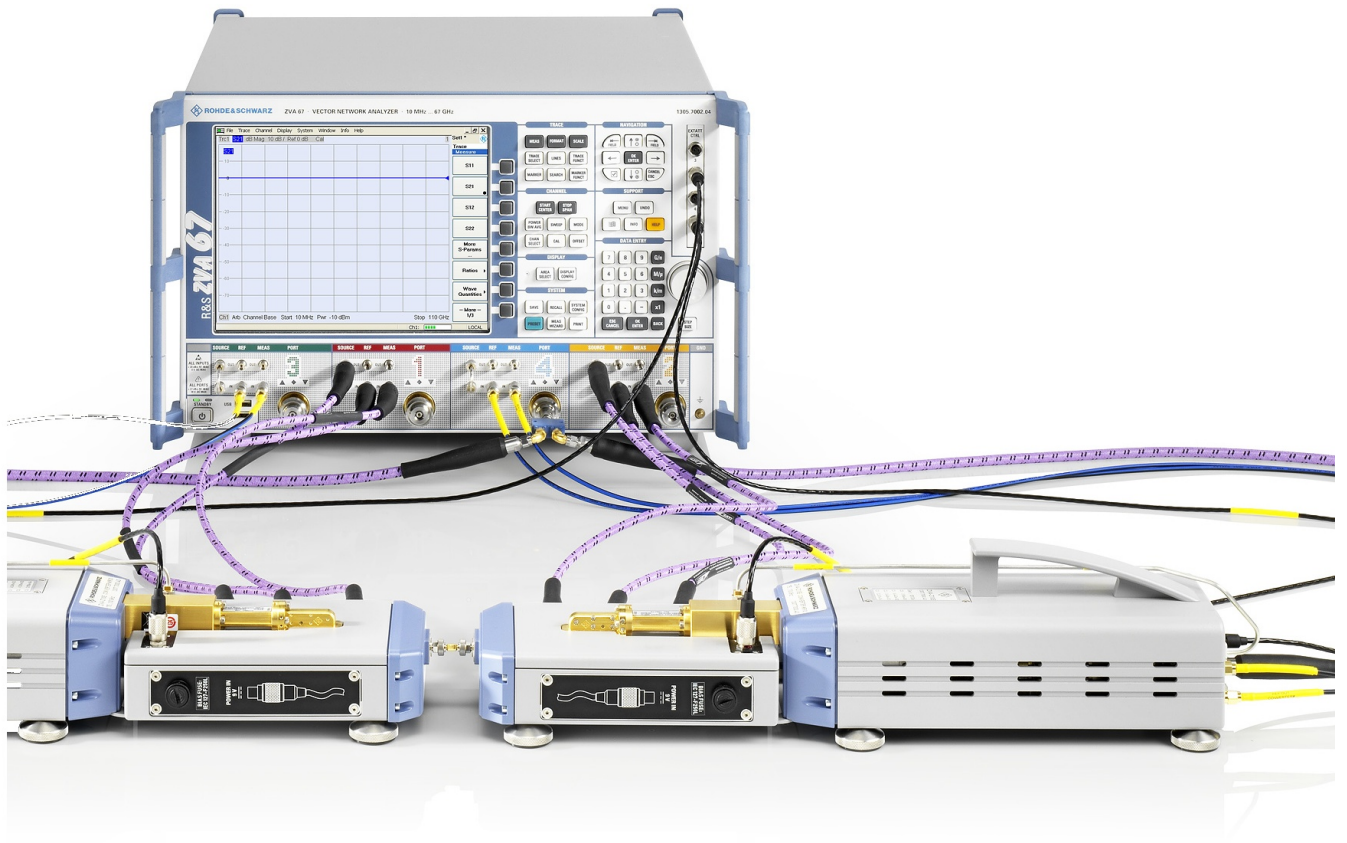

1314.4502.62 – 01

This Quick Start Guide describes the following network analyzer types:

- R&S® ZVA110, stock number 1312.7004.03, complete system (based on R&S®ZVA67)
- R&S® ZVA110, stock number 1312.7004.04, modular system

This guide complements the basic Quick Start Guide for all R&S®ZVA network analyzers, stock number 1145.1090.62 and the Quick Start Guide for frequency converters with electronic attenuators R&S®ZVA-ZxxxE, stock number 1307.7197.62. It describes the operation of the R&S®ZVA110 with external test sets.

© 2010 Rohde & Schwarz GmbH & Co. KG

Muehldorfstr. 15, 81671 Munich, Germany

Phone: +49 89 41 29 - 0

Fax: +49 89 41 29 12 164

E-mail: info@rohde-schwarz.com

Internet: <http://www.rohde-schwarz.com>

Printed in Germany – Subject to change – Data without tolerance limits is not binding.

R&S® is a registered trademark of Rohde & Schwarz GmbH & Co. KG.

Trade names are trademarks of the owners.

The following abbreviations are used throughout this guide: R&S®ZVAxx as R&S ZVAxx, R&S®ZVTxx as R&S ZVTxx, R&S®ZVA-BU as R&S ZVA-BU, R&S®ZVA-ZDxx as R&S ZVA-ZDxx, R&S®ZVA-Zxxx as R&S ZVA-Zxxx, R&S®ZV-Zxxx as R&S ZV-Zxxx, R&S®ZV-WRxx as R&S ZV-WRxx.

Contents

1	Safety Instructions	5
2	Preparing the Analyzer for Use	6
2.1	Operation with External Test Sets.....	6
2.2	R&S ZVA110 Network Analyzer Connectors.....	7
2.2.1	Test Port Connectors	7
2.3	Diplexer Connectors.....	8
2.3.1	Test Port.....	9
2.3.2	H/L SWITCH Connector.....	9
2.3.3	Rear Panel.....	9
2.3.4	Fuse Holder.....	10
2.4	Frequency Converter Connectors.....	11
2.4.1	Waveguide Flange.....	11
2.4.2	Rear Panel.....	11
2.4.2.1	Standby Switch.....	12
2.4.2.2	Power Supply Connector.....	12
2.4.2.3	Fuse Holder.....	13
2.4.2.4	RF Connectors – Input.....	13
2.4.2.5	IF Connectors – Output.....	14
2.4.2.6	Power Control Connector.....	14
2.5	Putting the Analyzer into Operation.....	14
2.5.1	Unpacking and Checking the Instrument.....	14
2.5.2	Positioning the Instrument.....	15
2.5.3	Adjusting the Feet of the Test Set.....	15
2.5.4	Connecting the Control Cable.....	16
2.5.5	Connecting the Power Control Cable.....	16
2.5.6	Connecting RF Cables.....	17
2.5.7	Connecting the Converter to the DC Supply.....	20
2.5.8	Switching on the External Test Set.....	20
2.5.9	Mounting a DUT.....	21
2.5.10	Replacing Fuses.....	21
2.6	Maintenance.....	21

2.7	Storing and Packing.....	21
3	Basic Operation.....	23
3.1	Required Equipment.....	23
3.2	Measurement Principle.....	23
3.3	Activating the ZVA110-BU Measurement Mode.....	23
3.4	Entering Power Coefficients.....	24
3.5	Connecting the External Test Sets.....	25
3.6	Power and Frequency Settings.....	26
3.7	Calibration.....	26
3.8	Measurement.....	27
3.9	Troubleshooting.....	28
3.10	Additional Information.....	29
4	Dismounting Frequency Converters.....	30
4.1	Service Re-Calibration.....	31
	Index.....	32

1 Safety Instructions

This vector network analyzer has been designed and tested in accordance with the EC Certificate of Conformity and has left the manufacturer's plant in a condition fully complying with safety standards.

NOTICE

Risk of instrument damage

To prevent instrument damage make sure to read through and observe the following safety instructions.

ESD protective measures

To protect the network analyzer and the external test sets against damage due to Electrostatic Discharge (ESD) use the wrist strap and grounding cord supplied with the network analyzer and connect yourself to the GND connector at the front panel of the analyzer. For details refer to the R&S ZVA Quick Start Guide, stock no. 1145.1090.62.

Input powers RF IN and LO IN

The RF input power at the connectors RF IN and LO IN must not exceed the maximum values quoted in the data sheet. The maximum values are below the maximum RF source power of the network analyzer. The "ZVA110-BU" mode ensures compatible source powers.

Before you connect your external test set to the network analyzer, always activate the "ZVA110-BU" mode using the "Frequency Converter" dialog (see [chapter 3.3, "Activating the ZVA110-BU Measurement Mode"](#), on page 23).

Avoid heavy shocks

Heavy shocks can damage inner parts of the devices. Shock-proof packing should therefore be used for storing or dispatching the analyzer and the external test sets.

Opening the instrument

Do not open the frequency converter and diplexer elements of the external test sets. Repair can only be done at the manufacturer's servicing department.

Using frequency converters separately

The frequency converters may be dismantled from the external test sets and used separately; see [chapter 4, "Dismounting Frequency Converters"](#), on page 30. The waveguide flanges of the dismantled converters and of the test port adapters must be protected against mechanical damage. Furthermore the waveguides must be shielded from dust.

Protect the waveguide flange of the dismantled converter by leaving a test port adapter connected. When the converter is not in use attach one of the included protective caps to the adapter. Avoid scratching the contact surfaces of the waveguide flanges.

2 Preparing the Analyzer for Use

The R&S ZVA110 vector network analyzer supports two essentially different measurement modes:

- Measurements with internal test sets cover a frequency range between 10 MHz and approx. 67 GHz.
The R&S ZVA110 types 03 and 04 are based on a four-port R&S ZVA67 vector network analyzer. The DUT can be connected to any of the four test ports of the R&S ZVA67. One to four-port measurements are supported as described in the R&S ZVA Quick Start Guide, stock number 1145.1090.62, and in the network analyzer's help system.
- Measurements with external test sets cover an extended frequency range between 10 MHz and 110 GHz. The DUT is connected to the 1 mm connector(s) at the front of the diplexers R&S ZVA-ZD110. This measurement mode is described in the present manual.

This chapter describes the external test sets and their connection to the DUT and to the R&S ZVA110 vector network analyzer. A typical measurement example is presented in [chapter 3, "Basic Operation"](#), on page 23.



The measurement mode is selected in the "Frequency Converter" tab of the "System Configuration" dialog: "NONE" for measurements with internal test sets, "ZVA110-BU" for external test sets. See [chapter 3.3, "Activating the ZVA110-BU Measurement Mode"](#), on page 23.

2.1 Operation with External Test Sets

The external test sets enable a frequency range between 10 MHz and 110 GHz. The analyzer combines two different measurement methods to achieve this extended range.

- At frequencies below approx. 67 GHz (i.e. in "low frequency" mode), the frequency converter in the external test set is bypassed. The source signals from test ports PORT 1 / 2 of the vector network analyzer unit are directly fed to the 1 mm test port connectors of the diplexers. The network analyzer measures the a-waves (reference channels) from REF OUT and the b-waves (measurement channels) from MEAS OUT on the diplexers. The connector groups PORT 3 / 4 on the network analyzer and the RF connectors LO IN, RF IN, REF OUT, MEAS OUT on the rear panel of the converters are not used.
- To achieve frequencies above approx. 67 GHz (i.e. to measure in "high frequency" mode), the source signals from test ports PORT 1 / 2 of the network analyzer are fed to the frequency converters; the converted signals are routed to the 1 mm test port connectors of the diplexers. The frequency converters use frequency multipliers to transform the source signal into a high-frequency stimulus signal. An additional Local Oscillator (LO) signal from PORT 4 of the analyzer is used for down-conversion of the reference and measurement channels. A power divider feeds the LO signal to

both the left and the right converter. This test setup ensures a stable phase relationship between both LO signals.

The analyzer measures the a-waves from REF OUT and the b-waves from MEAS OUT on the converters. The RF connectors REF OUT, MEAS OUT on the rear panel of the diplexers are not used.

The network analyzer automatically switches between low frequency and high frequency mode, depending on the stimulus frequency; see [chapter 2.3.2, "H/L SWITCH Connector"](#), on page 9. There is no need to change the test setup and cabling.

2.2 R&S ZVA110 Network Analyzer Connectors

The R&S ZVA110 is based on a four-port R&S ZVA67 vector network analyzer.

The front and rear panel controls and the connectors of the analyzer are described in the R&S ZVA Quick Start Guide, stock number 1145.1090.62 and in the analyzer's help system. The following sections describe special aspects for measurements with external test sets.

2.2.1 Test Port Connectors

The R&S ZVA67 of the R&S ZVA110 is equipped with four complete test port connector groups. The PORT 1 to PORT 4 connector groups are similar. Each of them consists of a bidirectional, ruggedized 1.85 mm connector and 3 pairs of 1.85 mm (V) connectors for direct generator and receiver access.

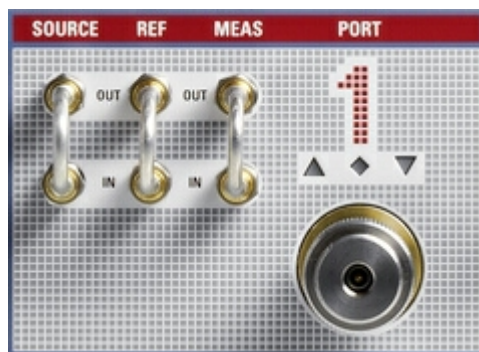

The connectors are used alternatively:

- The ruggedized 1.85 mm connector serves as a test port connector for one to four-port measurements with **internal** test set. In this operating mode, the three 1.85 mm connector pairs are generally not needed, however, they can provide an extended measurement functionality (see R&S ZVA Quick Start Guide, stock number 1145.1090.62, and the network analyzer's help system). Unused OUT/IN loops must be closed by means of jumpers as shown in the figure above.
- The SOURCE OUT connector provides the RF source signal for the **external** test set. SOURCE OUT is connected to the rear panel of the diplexer. In the low frequency range below approx. 67 GHz, REF IN and MEAS IN receive the reference waves and measured waves from the diplexer, respectively. The 1 mm connector of the diplexer

serves as a test port connector; the ruggedized 1.85 mm connectors at PORT 1 / 2 are not needed.

See also [chapter 2.1, "Operation with External Test Sets"](#), on page 6 and [chapter 2.5.6, "Connecting RF Cables"](#), on page 17.

NOTICE

Maximum input levels

The maximum RF input levels at the ruggedized 1.85 mm connectors and at all SOURCE, REF, and MEAS inputs according to the front panel labeling or the data sheet must not be exceeded. In addition, it is important that the signal fed in at the SOURCE, REF, and MEAS inputs contains no DC offset, as this may impair the measurements and even cause damage to the instrument.

2.3 Diplexer Connectors

The R&S ZVA110 is delivered with two fully assembled external test sets, each consisting of a diplexer R&S ZVA-ZD110 and a frequency converter R&S ZVA-Z110E.

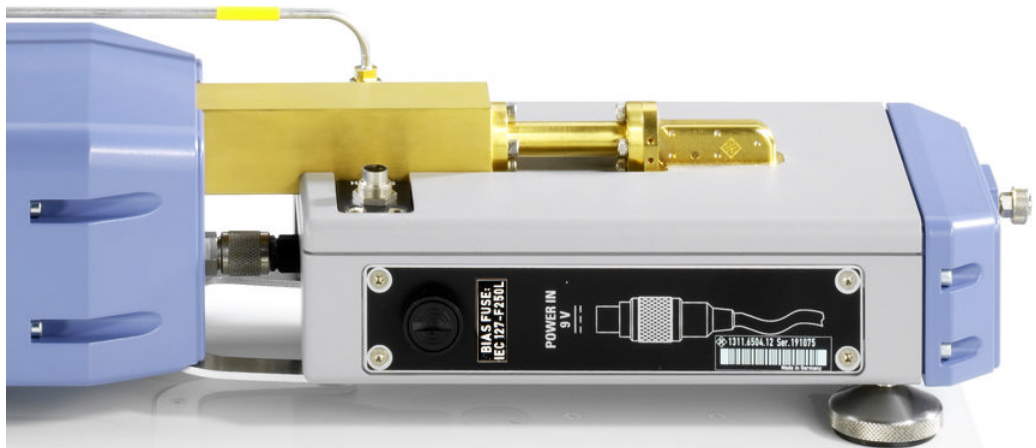

Fig. 2-1: Connection between diplexer (right) and frequency converter (left)

The connection of the diplexer and the frequency converter includes conducting lines for waves and power supply:

- The RF HIGH OUT connector on the top side of the diplexer is connected to RF IN on the rear panel of the converter using a semi-rigid RF cable.
- The waveguide connector on the top side of the diplexer is connected to the waveguide flange of the converter.
- The connection underneath the waveguide flange ensures the power supply of the diplexer.

An additional metal clamp at the bottom ensures mechanical stability.



Dismounting the frequency converter

The connection shown above is suitable for all operating modes and measurements. Only dismount the frequency converter from the diplexer if you want to use it separately; see [chapter 4, "Dismounting Frequency Converters"](#), on page 30.

2.3.1 Test Port



1 mm (m) connector, serves as an output for RF stimulus signals and as an input for the measured RF signals from the DUT (response signals).

- With a single external test set, it is possible to generate a stimulus signal and measure the response signal in reflection.
- With two external test sets, it is possible to perform full 2-port measurements.

NOTICE

Maximum input level, mechanical damage

Do not exceed the maximum input level at the test port according to the data sheet, especially when using active DUTs or external amplifiers.

To avoid mechanical damage when connecting devices to the 1 mm connector, always use the torque wrench supplied with the R&S ZVA110.

2.3.2 H/L SWITCH Connector

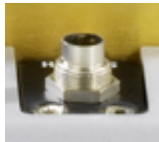

The H/L SWITCH connectors on the top side of each diplexer are input connectors for the control signals from the USER CONTROL connector on the rear panel of the R&S ZVA110 network analyzer unit; see [chapter 2.5.4, "Connecting the Control Cable"](#), on page 16.

2.3.3 Rear Panel

The rear panel of the diplexer provides input and output connectors for RF signals and a DC input. Connectors labeled LOW are used in low frequency mode only; see [chapter 2.1, "Operation with External Test Sets"](#), on page 6.



Fig. 2-2: Rear panel of the diplexer

- MEAS OUT LOW is a 1.85 mm (V) female connector which provides the measured signal (b-wave) in low frequency mode.

- RF IN LOW / HIGH is a 1.85 mm (V) female connector which receives the RF source signal from the R&S ZVA110 network analyzer unit. This connector is used in low frequency and in high frequency mode.
- REF OUT LOW is a 1.85 mm (V) female connector which provides the reference signal (a-wave) in low frequency mode.
- BIAS is a BNC connector which serves as a DC bias input for the external test set. The BIAS input is protected by an exchangeable fuse; see [chapter 2.3.4, "Fuse Holder"](#), on page 10.

MEAS OUT, RF IN, and REF OUT are connected to the corresponding 1.85 mm connectors of PORT 1 / 2 at the R&S ZVA110 network analyzer unit. The complete RF connection of the external test set is described in [chapter 2.5.6, "Connecting RF Cables"](#), on page 17.

NOTICE

Maximum input power at RF IN

The RF input power at the RF IN connector must not exceed the maximum value quoted in the data sheet. The maximum value is below the maximum RF source power of the network analyzer. The "ZVA110-BU" mode ensures compatible source powers.

Before you connect your external test set to the network analyzer, always activate the "ZVA110-BU" mode using the "Frequency Converter" dialog (see [chapter 3.3, "Activating the ZVA110-BU Measurement Mode"](#), on page 23).

NOTICE

Maximum input voltage at BIAS and EMI suppression

The maximum nominal input voltage and current for the BIAS connector must not exceed the value quoted in the data sheet. Use a double-shielded cable and terminate open cable ends with 50 Ω to ensure successful control of electromagnetic radiation during operation.

The LED labeled ON lights when the diplexer is properly power-supplied. If the LED does not light, check the following:

- The power connection between the diplexer and the converter must be in place (see [figure 2-1](#)).
- The converter must be power-supplied and switched on.
- The fuse at the converter must be intact.

2.3.4 Fuse Holder



A fuse of type IEC 127-F250L at the front protects the diplexer from excess input current at the BIAS connector. The frequency converter is protected by a fuse of different type; see [chapter 2.4.2.3, "Fuse Holder"](#), on page 13.

For fuse replacement refer to [chapter 2.5.10, "Replacing Fuses"](#), on page 21.

2.4 Frequency Converter Connectors

The R&S ZVA110 is delivered with two fully assembled external test sets, as described in [chapter 2.3, "Diplexer Connectors"](#), on page 8. The open connectors of the converter are described in the following sections.

2.4.1 Waveguide Flange

For normal operation, the waveguide adapter with the precision waveguide flange mounted on top is connected to the diplexer. If the frequency converter is used separately, a DUT can be connected to the waveguide flange. Refer to the Quick Start Guide for frequency converters R&S ZVA-ZxxxE, stock no. 1307.7197.62, for detailed information and safety instructions. This Quick Start Guide is posted on the R&S internet.

See also [chapter 4, "Dismounting Frequency Converters"](#), on page 30.

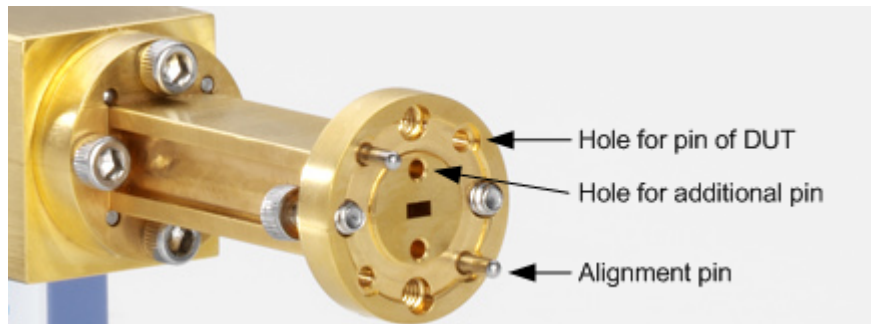

Fig. 2-3: Test port adapter of the frequency converter

2.4.2 Rear Panel

The rear panel of the frequency converter provides the connectors and control elements shown below.



Fig. 2-4: Rear view of the frequency converter

The connectors are described in the following sections.

2.4.2.1 Standby Switch

The standby toggle switch connects (ready state) or disconnects (standby state) the internal modules of the frequency converter from the power supply. This includes the output connector for the power supply connection to the diplexer (see [figure 2-1](#)).



Fig. 2-5: Standby switch and LEDs

A green light-emitting diode (LED) next to the switch indicates that the instrument is in ready state. An orange LED further to the right indicates that the instrument is in standby state. These LEDs are only lit when the converter is properly connected to the power supply and the fuse of the instrument is intact.

2.4.2.2 Power Supply Connector



To supply the frequency converter, connect the external DC power supply provided with the converter to the 9 V / 1.1 A DC input. For details see [chapter 2.5.7](#), "Connecting the Converter to the DC Supply", on page 20.

Always switch the instrument to standby state before removing the power supply.

NOTICE**Risk of instrument damage**

The input voltage and current must not exceed the maximum values according to the rear panel labeling or the data sheet.

Always use the DC power supply included in the delivery to power your frequency converter.

2.4.2.3 Fuse Holder

A fuse of type IEC60127 T1 L/H protects the frequency converter from excess input voltages at the power supply connector. The diplexer is protected by a fuse of different type; see [chapter 2.3.4, "Fuse Holder"](#), on page 10.

For fuse replacement see [chapter 2.5.10, "Replacing Fuses"](#), on page 21.

2.4.2.4 RF Connectors – Input

Two 3.5 mm input connectors:

- RF IN receives the RF source signal from the diplexer. A semi-rigid cable connects RF IN to the RF HIGH OUT connector on the top side of the diplexer.
- LO IN receives the local oscillator signal from the R&S ZVA110 network analyzer unit.

Both input connectors are only used in high frequency mode. The complete RF connection of the external test set is described in [chapter 2.5.6, "Connecting RF Cables"](#), on page 17.

NOTICE**Risk of instrument damage**

The RF input power at the connectors RF IN and LO IN must not exceed the maximum values quoted in the data sheet. The maximum values are below the maximum RF source power of the network analyzer. The "ZVA110-BU" mode ensures compatible source powers.

Before you connect your external test set to the network analyzer, always activate the "ZVA110-BU" mode using the "Frequency Converter" dialog (see [chapter 3.3, "Activating the ZVA110-BU Measurement Mode"](#), on page 23).

2.4.2.5 IF Connectors – Output

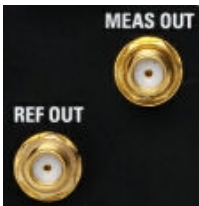

Two SMA output connectors:

- MEAS OUT provides the measured signal (b-wave) for the R&S ZVA110 network analyzer unit.
- REF OUT provides the reference signal (a-wave) for the R&S ZVA110 network analyzer unit.

The output connectors are connected to the corresponding SMA connectors of PORT 3 / 4 at the R&S ZVA110 network analyzer unit. Both are only used in high frequency mode. The complete RF connection of the external test set is described in [chapter 2.5.6, "Connecting RF Cables"](#), on page 17.

2.4.2.6 Power Control Connector



The three-pin power control connector receives the control signal for the source power of the vector network analyzer. The control signal is used in the high frequency range above approx. 67 GHz.

For correct connection read [chapter 2.5.4, "Connecting the Control Cable"](#), on page 16.

2.5 Putting the Analyzer into Operation

The basic steps to be taken when setting up the R&S ZVA110 network analyzer unit for the first time are described in the R&S ZVA Quick Start Guide, stock number 1145.1090.62 and in the network analyzer's help system. This section gives additional information related to operation with external test sets.

2.5.1 Unpacking and Checking the Instrument

The R&S ZVA110 network analyzer unit is shipped in a cardboard box; for unpacking instructions refer to the R&S ZVA Quick Start Guide, stock number 1145.1090.62. Each of the two external test sets is shipped in a separate wooden case. The external test sets are fully mounted and accompanied by the necessary cables and additional equipment.

When you receive the shipment, please take the following steps:

1. Unpack the test sets and the other contents of the wooden case.
2. Check the contents of the cases against the list of accessories to ensure that all items are included.
3. Remove the protective caps from the 1 mm test ports at the front of the diplexer elements and carefully inspect the converters and diplexers to make sure that they were not damaged during shipment.

Should the external test sets be damaged, immediately notify the forwarder who shipped them to you. External test sets returned to Rohde & Schwarz or sent in for repair must be packed in the original wooden cases. The cases should also be kept for storing the test sets and the accessories.

See also [chapter 2.7, "Storing and Packing"](#), on page 21 and [chapter 4.1, "Service Re-Calibration"](#), on page 31.

2.5.2 Positioning the Instrument

The R&S ZVA110 is designed for use under laboratory conditions on a bench top. The surface of the bench top should be flat. The external test sets must be used in horizontal position.

The general ambient conditions required at the operating site are as follows:

- The ambient temperature must be in the ranges specified for operation and for compliance with specifications (see data sheet).
- All ventilation openings must be unobstructed.

NOTICE

Risk of instrument and DUT damage

To avoid damage of electronic components of the DUT and the R&S ZVA110, the operating site must be protected against electrostatic discharge (ESD).

To prevent ESD damage use the wrist strap and grounding cord supplied with the network analyzer and connect yourself to the GND connector at the front panel of the analyzer. For details refer to the R&S ZVA Quick Start Guide.

2.5.3 Adjusting the Feet of the Test Set

The frequency converter can be used with three or four feet attached to the bottom side. It is recommended to use three feet: two in front and one in the middle of the rear. Two additional feet support the diplexer.

In most cases the external test set can be aligned as follows: Screw the diplexer feet and the front feet into the instrument as far as possible and use the rear foot to align the entire test set parallel to the surface of the bench top. When you connect a DUT in-between two test sets (see [chapter 2.5.9, "Mounting a DUT"](#), on page 21) use the diplexer feet for further alignment.



Fig. 2-6: Setup with one rear foot (left) and two rear feet (right)

2.5.4 Connecting the Control Cable

Switchover between low frequency and high frequency mode is automatically controlled from the R&S ZVA110 network analyzer unit. If you operate your R&S ZVA110 in high frequency mode, use the "H/L Switch" cable supplied with the R&S ZVA110 to connect the USER CONTROL connector on the rear panel of the network analyzer unit to the H/L SWITCH connectors on the top side of each diplexer. The cable end labeled H/L SWITCH PORT 1 is intended for the "left" diplexer (connected to the analyzer ports 1 and 3); the cable end labeled H/L SWITCH PORT 2 is for the "right" diplexer (connected to ports 2 and 4).

The H/L switch mechanism is controlled by the drive port bits no. 1 and 2 (pins no. 16 and 17) of the USER CONTROL connector. For a detailed description of the connector refer to the help system of your network analyzer.



Low frequency mode

The control cable is not needed in low frequency mode. It is recommended to remove the control cable if no frequencies above approx. 67 GHz are measured, even if the DUT is connected to the 1 mm test port connectors of the diplexers.

2.5.5 Connecting the Power Control Cable

The source power of the vector network analyzer is controlled from the R&S ZVA67 vector network analyzer. Connect the 3-pin control connector at the rear panel of the converter to the output connector of option R&S ZVA-B8 (EXTATT CTRL) at the top right of the R&S ZVA front panel using the control cable supplied with the converter.



The numbers below the EXTATT CTRL connectors denote the controlled analyzer ports. Control connector numbers and analyzer port numbers must always be the same.

2.5.6 Connecting RF Cables

The R&S ZVA110 is delivered with two fully assembled external test sets, each consisting of a diplexer R&S ZVA-ZD110 and a frequency converter WR10 R&S ZVA-Z110E. The "internal" connection between the diplexers and frequency converters is described in [chapter 2.3, "Diplexer Connectors"](#), on page 8. The left test set is intended for PORT 1 / PORT 3 of the R&S ZVA67 network analyzer; the right test set for PORT 2 / PORT 4. Connection of the two test sets is analogous.

NOTICE

Risk of instrument damage

The RF input power at the RF IN and LO IN connectors must not exceed the maximum value quoted in the data sheet. The maximum value is below the maximum RF source power of the network analyzer. The "ZVA110-BU" mode ensures compatible source powers.

Before you connect your external test set to the network analyzer, always activate the "ZVA110-BU" mode using the "Frequency Converter" dialog (see [chapter 3.3, "Activating the ZVA110-BU Measurement Mode"](#), on page 23).

NOTICE

Connecting cables, risk of damage

A full set of connecting cables including the necessary adapters (for instrument types 03 and 04) is supplied with the R&S ZVA110. It is strictly recommended to use these high-quality cables for the RF connection. For accurate measurement results, RF cables must have a low attenuation and an excellent phase stability.

Tightening the cable connectors too much may cause damage. Loose connections can result in inaccurate measurement results. For these reasons always use appropriate torque wrenches, suitable for the different connectors types. A torque wrench for the delicate 1 mm connector is supplied with the R&S ZVA110.

Some of the RF connections are only used while the network analyzer operates in the low frequency range (below approx. 67 GHz) or in the high frequency range (above approx. 67 GHz). It is strongly recommended though to establish all RF connections, as this ensures full flexibility and maximum accuracy .

1. Ensure that the converter is in standby state or disconnected from the power supply (see [chapter 2.4.2.1, "Standby Switch"](#), on page 12).
2. Ensure that the "ZVA110-BU" mode is activated at the network analyzer (see [chapter 3, "Basic Operation"](#), on page 23).
3. Connect the RF input and output connectors of the diplexers and the frequency converters as shown below.

The following figure shows the cabling of the left test set to the R&S ZVA67 network analyzer. Notice that the test port connector PORT 4 provides the LO IN signal for both

the left and the right converters. An appropriate RF power divider R&S ZV-Z1227 is supplied with the R&S ZVA110.

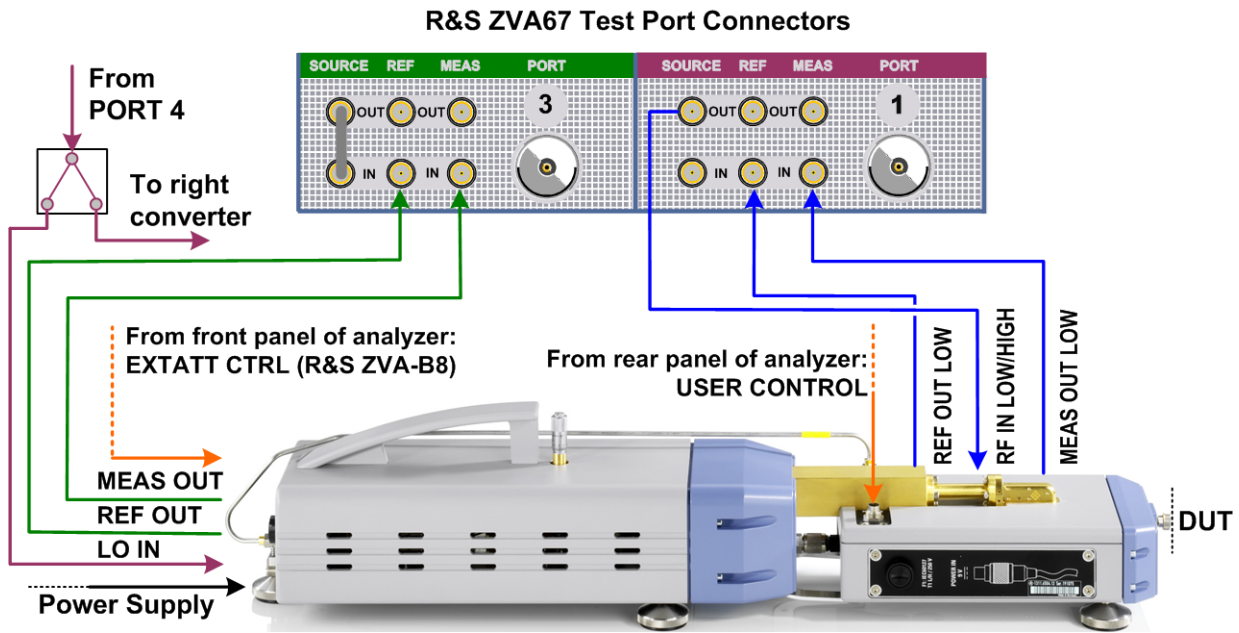

Fig. 2-7: Connection of left test set

Table 2-1: RF connection for left external test set

R&S ZVA67 connector	Ext. test set connector	Cable	Used at frequencies
PORT 1 – SOURCE OUT	Diplexer – RF IN	R&S ZV-Z196 67 GHz, 1.85 mm (M) – 1.85 mm (M), 0.6 m	LOW / HIGH
PORT 1 – REF IN	Diplexer – REF OUT	R&S ZV-Z196 67 GHz, 1.85 mm (M) – 1.85 mm (M), 0.6 m	LOW
PORT 1 – MEAS IN	Diplexer – MEAS OUT	R&S ZV-Z196 67GHz, 1.85 mm (M) – 1.85 mm (M), 0.6 m	LOW
PORT 3 – SOURCE OUT must be connected to PORT 3 – SOURCE IN ¹⁾	–	–	–
PORT 3 – REF IN	Converter – REF OUT	CABLE MEAS, 1.55 m	HIGH
PORT 3 – MEAS IN	Converter – MEAS OUT	CABLE REF, 1.55 m	HIGH

1) The output signal at the ruggedized test port PORT 3 can be used as an auxiliary signal, e.g. an LO signal for a mixer under test.

Table 2-2: RF connection for right external test set

R&S ZVA67 connector	Ext. test set connector	Cable	Used at frequencies
PORT 2 – SOURCE OUT	Diplexer – RF IN	R&S ZV-Z196, 1.85 mm (M) – 1.85 mm (M), 0.6 m	LOW / HIGH
PORT 2 – REF IN	Diplexer – REF OUT	R&S ZV-Z196, 1.85 mm (M) – 1.85 mm (M), 0.6 m	LOW
PORT 2 – MEAS IN	Diplexer – MEAS OUT	R&S ZV-Z196, 1.85 mm (M) – 1.85 mm (M), 0.6 m	LOW
PORT 4 – ruggedized connector	Power divider to both converter – LO IN connectors	R&S ZV-Z193, 3.5 mm (M) – 3.5 mm (M), 1.5 m R&S ZV-Z1227, POWER DIVIDER	HIGH
PORT 3 – SOURCE OUT must be connected to PORT 3 – SOURCE IN	–	–	–
PORT 4 – REF IN	Converter – REF OUT	CABLE MEAS, 1.55 m	HIGH
PORT 4 – MEAS IN	Converter – MEAS OUT	CABLE REF, 1.55 m	HIGH

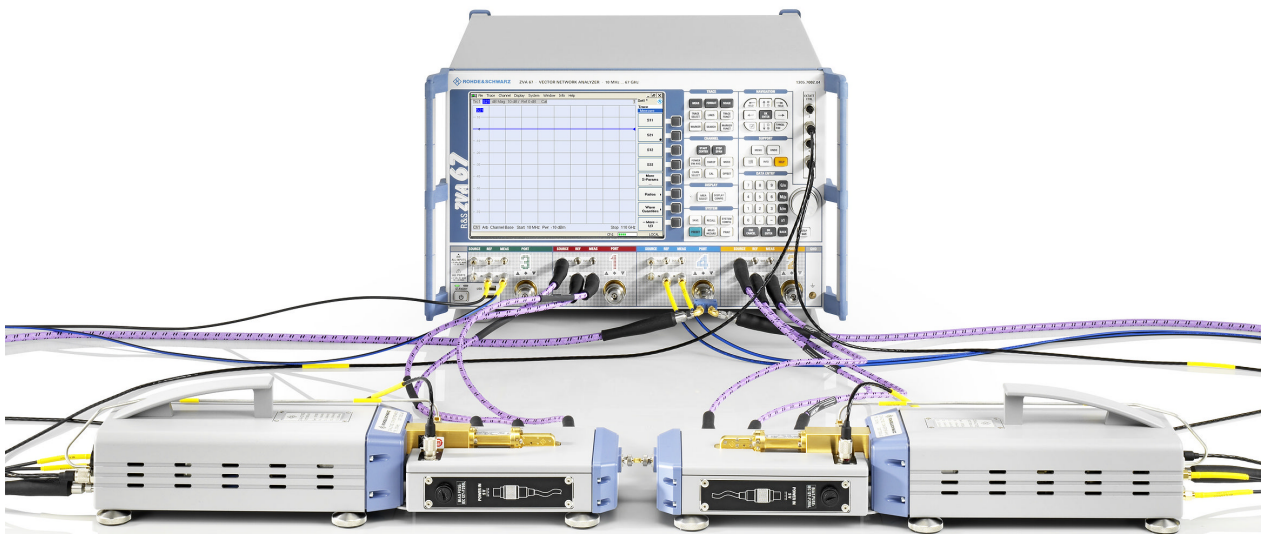
**Fig. 2-8: Complete test setup for 2-port transmission measurement**

Right and left diplexers and converters

A label on the rear panel of the network analyzer shows the two diplexer and converter units with their position. The label contains the following information.

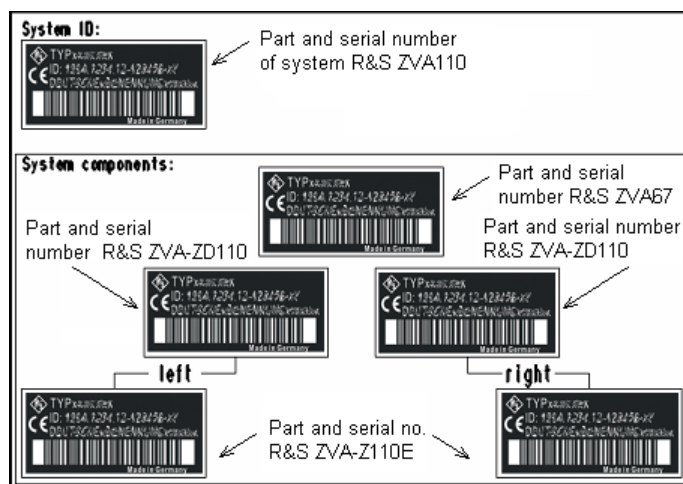

Fig. 2-9: System component information



Compliance with rated specifications

The "left" external test set (consisting of one diplexer R&S ZVA-ZD110 plus one converter R&S ZVA-Z110E) is connected to the analyzer ports 1 and 3; the "right" external test set to the analyzer ports 2 and 4. Compliance with the rated specifications requires a system setup according to the rear panel labeling. Never interchange the left and right diplexer and converter units, and never interchange diplexers and converters from different R&S ZVA110 systems.

2.5.7 Connecting the Converter to the DC Supply

An external DC power supply and several plug adapters are provided with each of the external test sets. Select the appropriate adapter and attach it to the power supply. To remove a mounted adapter press the small button next to the adapter and push the adapter away from the button.

Connect the power supply to the 9 V / 1.1 A DC input at the rear panel of the frequency converter (see [chapter 2.4.2.2, "Power Supply Connector"](#), on page 12) and to a power outlet. The power supply supports input AC voltages between 100 V and 240 V and frequencies between 47 Hz and 63 Hz.

A lit LED next to the standby switch indicates that the power supply operates appropriately. If neither of the two LEDs is lit, check the fuse of the instrument (see [chapter 2.5.10, "Replacing Fuses"](#), on page 21).

2.5.8 Switching on the External Test Set

The standby toggle switch is located at the rear panel (see [chapter 2.4.2.1, "Standby Switch"](#), on page 12). To switch the external test set to ready state, press the key. The green LED next to the switch must be lit now.

After switching the external test set to the ready state a warm-up time of one hour is required to ensure accurate measurements. The instrument is only warmed-up in ready state, not in standby state.

2.5.9 Mounting a DUT

The DUT must be screwed to the 1 mm test port connector at the front of the diplexer. A tight connection is very important to ensure precise calibration and measurement results. Depending on the connectors of the DUT, additional adapters may be required.

For two-port measurements involving two external test sets connected to one DUT, the test sets and the DUT must be aligned accurately, using the adjustable feet of the test sets.

2.5.10 Replacing Fuses

The frequency converter is protected by a fuse of type IEC60127 T1 L/H, the diplexer by a fuse of type IEC127-F250L. To replace a fuse open the fuse holder by slightly turning the lid counter-clockwise, preferably using a small coin. Replacement fuses are provided with the instrument.

2.6 Maintenance

The external test sets do not require any special maintenance. Make sure that the air vents of the frequency converters are not obstructed. The outside is suitably cleaned using a soft, line-free dust cloth.

NOTICE

Risk of damage

Cleaning agents contain substances that may damage the external test set, e.g. the front panel labeling or plastic parts.

Never use cleaning agents such as solvents (thinners, acetone etc.), acids, bases or other substances.

For our support center address and a list of useful R&S contact addresses refer to the pages at the beginning of this guide.

2.7 Storing and Packing

The R&S ZVA110 network analyzer unit and the external test sets can be stored in the temperature range quoted in the data sheet. When stored for a longer period of time the devices should be protected against dust.

It is strongly recommended to transport and store the external test sets in the original wooden case. The 1 mm test port of the diplexer should be protected by its cap; see also [chapter 2.5.1, "Unpacking and Checking the Instrument"](#), on page 14.

The waveguide flanges of dismantled frequency converters must be protected against mechanical damage and shielded from dust; see [chapter 4, "Dismounting Frequency Converters"](#), on page 30.

3 Basic Operation

This chapter describes the use of an R&S ZVA110 vector network analyzer with two external test sets for 2-port transmission measurements.

One-port reflection measurements can be performed in a similar way using a single external test set.

3.1 Required Equipment

The R&S ZVA110 system is delivered with all measurement equipment needed. An additional 1 mm calibration kit is required for system error correction (calibration).

3.2 Measurement Principle

The principle of the measurement with external test sets is described at the beginning of this guide; refer to [chapter 2.1, "Operation with External Test Sets"](#), on page 6.

The measurement involves the following steps:

1. Activation of the "ZVA110-BU" mode for measurements with external test set
2. Entry of power coefficients (when an external test set is used for the first time).
3. Connection of the external test sets
4. Power and frequency settings
5. Power calibration using an appropriate external power meter
6. System error correction (calibration) using a suitable calibration kit
7. Connection of the DUT and measurement

3.3 Activating the ZVA110-BU Measurement Mode

After a factory preset, the R&S ZVA67 is configured for measurements using the internal test sets. You have to activate the "ZVA110-BU" mode explicitly before you connect the external test sets.

To (re-)activate the "ZVA110-BU" mode,

1. Click "System > System Config ..." and open the "Frequency Converter" tab of the "System Configuration" dialog.
2. Select "Type : ZVA110-BU".
3. Click "Apply" to activate the mode.

4. If you use your vector network analyzer for the first time, click "Coefficients" to enter the power coefficients; see [chapter 3.4, "Entering Power Coefficients"](#), on page 24.
5. "Close" the "System Configuration" dialog.



Analyzer settings with active "ZVA110-BU" mode

In "ZVA110-BU" mode, the frequency and level settings of the network analyzer are automatically set to be compatible with the external test sets. "Low Phase Noise" is enabled, Automatic Level Control (ALC) is disabled. The frequency and levels of all ports are displayed in the "Port Configuration" dialog ("Channel > Mode > Port Config ...").

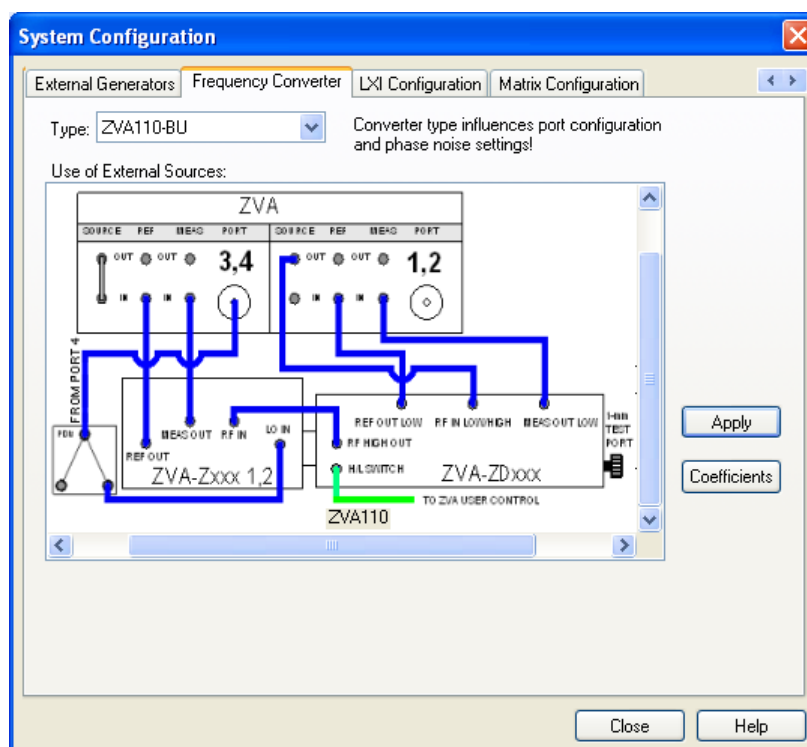

Fig. 3-1: Frequency Converter dialog

3.4 Entering Power Coefficients

For accurate control of the converter output power, the R&S ZVA67 analyzer must know the (non-linear) current-power characteristic of the frequency converters. The characteristic is sufficiently described by a third-order polynomial. A label with the four polynomial coefficients c_0 , c_1 , c_2 , and c_3 is affixed to each converter.

When the R&S ZVA110 is used for the first time, it is recommended to check whether the power coefficients on the converter labels correspond to the entries in the analyzer dialog. Proceed as follows:

1. Activate the "ZVA110-BU" mode following the first steps in [chapter 3.3, "Activating the ZVA110-BU Measurement Mode"](#), on page 23.
2. In the "Frequency Converter" dialog, press "Coefficients".
3. In the "Power Coefficients" dialog opened, clear "Use default coefficients". Adjust the coefficients in the dialog to the converter coefficients, if necessary.

The numbers of the table rows in the dialog denote the analyzer ports for the converters.

4. Repeat the last step for both frequency converters/external test sets.

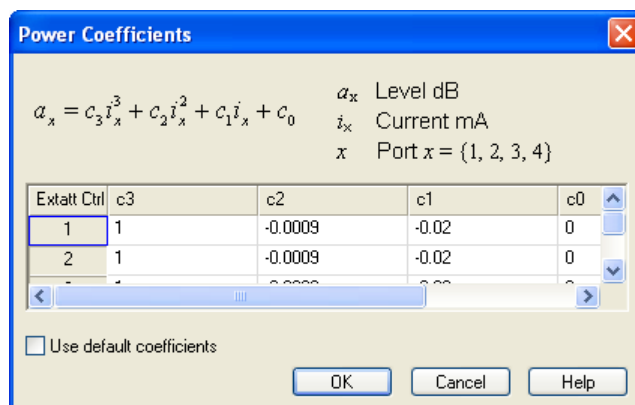

Fig. 3-2: Entry of power coefficients for analyzer port 1

3.5 Connecting the External Test Sets

Each of the external test sets must be connected to the R&S ZVA110 base unit, the power supply and the DUT. Please refer to the following sections for details.

- Power control connection: See [chapter 2.5.5, "Connecting the Power Control Cable"](#), on page 16
- H/L SWITCH (control connection): [chapter 2.5.4, "Connecting the Control Cable"](#), on page 16
- RF connection: See [chapter 2.5.6, "Connecting RF Cables"](#), on page 17
- Power supply: See [chapter 2.5.7, "Connecting the Converter to the DC Supply"](#), on page 20
- DUT (usually connected after calibration): See [chapter 2.5.9, "Mounting a DUT"](#), on page 21

3.6 Power and Frequency Settings

While the "ZVA110-BU" mode is active, the "Channel > Stimulus" settings of the network analyzer control the frequency and power range of the converters. The "Channel > Mode > Port Configuration" dialog shows an additional row for each converter. The "Power" and "Frequency" settings in the "Source" section of the dialog serve different purposes:

- The "Power" setting defines the output power for each external test set. After a source power calibration of the converter ports 1 and 2, the analyzer will generate the selected source powers at the 1 mm test port connectors of the external test sets; see [chapter 3.7, "Calibration"](#), on page 26. Port 4 provides the local oscillator signal for the converters. The default source power setting ensures a suitable input level of approx. 7 dBm at the LO IN connectors.
- The source frequencies at the 1 mm test ports are essentially determined by the port frequencies of the analyzer: The "Port 1" and "Port 2" source frequencies define the source frequencies of the left and right external test sets, respectively. The "Converter Port 1" and "Converter Port 2" frequency settings in the "Port Configuration" dialog define the frequency axes for the source power calibrations, but do not affect the source frequencies at the 1 mm test ports. For best accuracy, ensure that the correct converter frequencies are set, especially if the test setup contains additional frequency-converting components.

Example:

In the example below, the frequency at the NWA "Port 1" has been increased by a 1 GHz offset. The same offset has been entered for "Converter Port 1". This ensures a correct frequency axis during the power calibration.

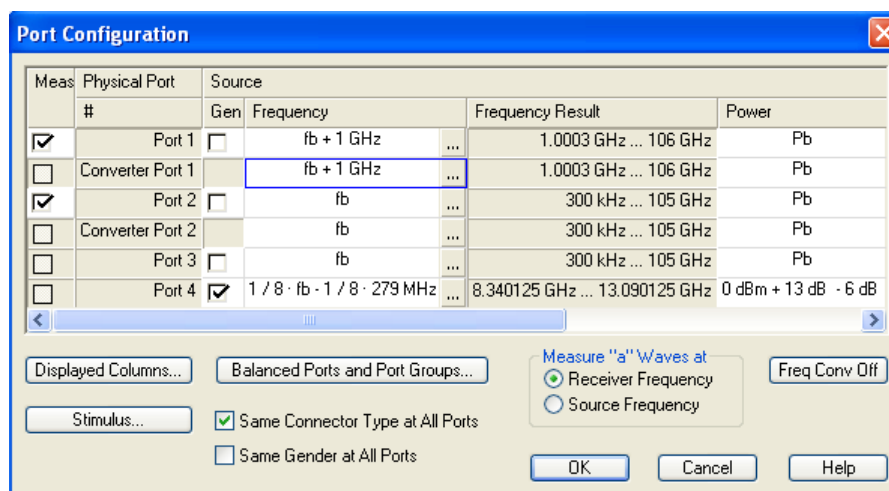

Fig. 3-3: Converter frequency and power settings

3.7 Calibration

A source power calibration for an external test set requires an appropriate external power meter, to be connected to the converter's 1 mm test port connector. The power meter is

configured in the ordinary way using the "System Configuration > External Power Meters" tab.

To perform the source power calibration, proceed as follows:

1. Connect the power meter and open the "Channel > Calibration > Start Power Cal > Source Power Cal" dialog.
2. Select your converter and source port from the "Source" pull-down list (e.g. "Conv 1" for the left external test set connected to Ports 1 and Port 3).
3. Click "Modify Settings" and ensure that both "Flatness Cal" and "Reference Receiver Cal" are checked.
4. If your test setup causes strong nonlinear effects, you can choose a "Convergence Factor" different from one.
5. Start the calibration sweep.



To ensure an accurate source power calibration and quick convergence, use the correct power coefficients; see [chapter 3.7, "Calibration"](#), on page 26.

A receiver power calibration of the b-waves (without external power meter, using the "Receiver Power Calibration" dialog) is possible after completed source power calibration.

After the power calibration procedure a system error correction is recommended. Measurements with external test sets require a 1 mm calibration kit for system error correction.

3.8 Measurement

After power calibration and system error correction, the millimeter wave measurement can be performed like any other network analyzer measurement. The analyzer may perform a frequency or power sweep. The "Port Configuration" settings (together with the "Stimulus" settings), determine the sweep range of the converted signals (for a frequency sweep, the input and output frequencies at the DUT ports). All measured quantities (S-parameters, wave quantities, ratios etc.) and other trace settings are available.

The following example shows a transmission measurement on a through connection in the frequency range between 10 MHz and 110 GHz.

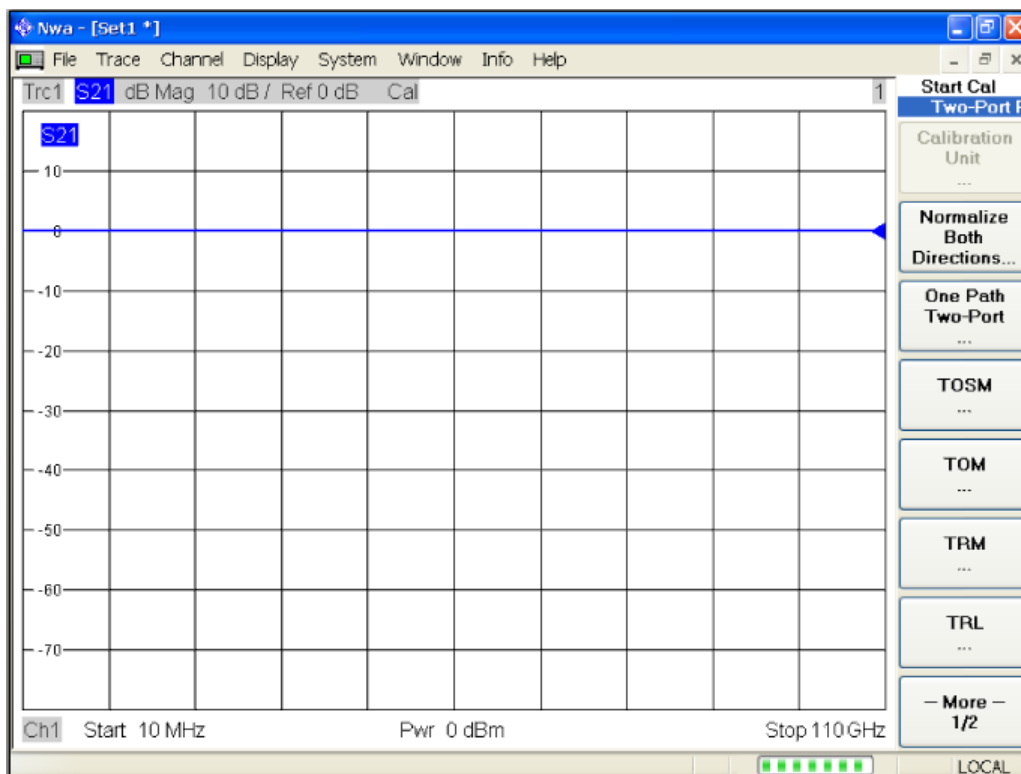

Fig. 3-4: Transmission measurement with an R&S ZVA110



For best measurement accuracy, observe the following rules:

- Enter the correct power coefficients of all frequency converters; see [chapter 3.4, "Entering Power Coefficients"](#), on page 24.
- Perform a source power calibration; see [chapter 3.7, "Calibration"](#), on page 26. Using output powers at the 1 mm connectors outside the calibrated range generally impairs the measurement accuracy. The effect is enhanced if the power coefficients are not correct.
- Perform a system error correction for the power-calibrated test setup using an appropriate calibration kit.

3.9 Troubleshooting

The table below lists possible errors and remedies.

Error	Possible cause	Remedy
No output signal, LED next to the mains switch on the rear of the converter panel off.	Converter not power-supplied	Check power supply and fuse (see chapter 2.5.8, "Switching on the External Test Set" , on page 20).
Switchover between low frequency and high frequency mode fails	Control connection not established or Port 1 and Port 2 connectors interchanged	Check connecting "H/L Switch" cable (see chapter 2.5.4, "Connecting the Control Cable" , on page 16).

Error	Possible cause	Remedy
Inconclusive measurement results	REF and MEAS cables at the diplexer or at the converter are interchanged	See figure 2-7 .
Measurement shows noise only	No supply power at the diplexer unit	See chapter 2.3, "Diplexer Connectors" , on page 8.
Power control fails, external test sets operate at maximum output power.	Power control connection not established	Check connecting cables and port assignment of control connectors.
Inaccurate source levels at the 1 mm ports	Insufficient settling time, especially for fast sweep and strong power variations	Increase sweep time ("Channel > Sweep > Sweep Time").
Inaccurate source levels, even at reduced speed	Power coefficients entered and converters do not match, e.g. the coefficients of port 1 and port 2 are interchanged	Make sure that all coefficients are correct and assigned to the right analyzer ports (see chapter 3.4, "Entering Power Coefficients" , on page 24).

3.10 Additional Information

For a comprehensive description of R&S ZVA analyzers including frequency conversion and remote control refer to the R&S ZVA help system or to the printable operating manual, which is available for download at <http://www.rohde-schwarz.com/product/zva>.

Application notes related to frequency converters are also available for download, see <http://www.rohde-schwarz.com/product/zva-z>.

The text book "Fundamentals of Vector Network Analysis" by Michael Hiebel is an ideal complement for the information given in the user documentation. The book combines theoretical background and practical measurements on an R&S ZVA network analyzer. In case of interest please contact your local R&S office.

4 Dismounting Frequency Converters

The frequency converters may be dismantled from the external test sets and used separately. They can be used in combination with any network analyzer R&S ZVA or R&S ZVT which has an upper frequency limit of 20 GHz or higher (R&S ZVT 20, R&S ZVA 24, R&S ZVA 40 ...) and is equipped with option R&S ZVA-B8.

The frequency converters provide:

- A frequency range between 75 GHz and 110 GHz
- Direct connection of DUTs with waveguide flanges
- System error correction using waveguide calibration kits (e.g. R&S ZV-WR10)

For detailed information about measurements with external frequency converters refer to the Quick Start Guide R&S ZVA-Z90E / -Z110E, stock no. 1307.7197.62, which is posted on the R&S internet, and to your network analyzer's help system.

Dismounting the converter

To detach the frequency converter from the diplexer:

1. Unscrew the semi-rigid RF cable between the RF HIGH OUT connector on the top side of the diplexer and the RF IN connector on the rear panel of the converter.
2. Turn the external test set by 90 deg so that the diplexer connectors point in upward direction.
3. Open the corrugated union screw of the power supply cable between the converter the diplexer manually, leaving the cable attached to the diplexer.
4. Open two screws at the U-shaped metal clamp, leaving the clamp attached to either the converter or the diplexer.
5. Put the external test set back on its feet.
6. Use the hexball driver supplied with the R&S ZVA110 to open all screws at the waveguide flange, leaving the adapter attached to the converter.
7. Carefully detach the two devices in horizontal direction.

NOTICE

Risk of damaging waveguide flanges

The waveguide flanges of the dismantled converter and of the test port adapters must be protected against mechanical damage. Furthermore the waveguides must be shielded from dust.

Protect the waveguide flange of the dismantled converter by leaving a test port adapter connected. When the converter is not in use attach one of the included protective caps to the adapter. Avoid scratching the contact surfaces of the waveguide flanges.

Re-mounting the converter

To re-mount the converter, perform the steps described above in reverse order. Use a torque wrench to tighten the semi-rigid RF cable to the SMA connectors and notice that the RF cables of the left and right test sets are not identical.

4.1 Service Re-Calibration

For accurate measurements the R&S ZVA110 must be re-calibrated by Rohde & Schwarz after the calibration interval in the data sheet has elapsed. Calibration involves all components of the test system, including the R&S ZVA67 network analyzer and both external test sets.

To help us carry out your order as quickly as possible, please always return the complete test system. Observe the label on the rear panel of the network analyzer to ensure that all components belong together.

Index

B

Basic operation	23
BIAS	9

C

Calibration	26
Control connector	14

D

DC power	20
Diplexer	8
Dismounting converters	30
DUT	21

F

Feet	15
Frequency converter (dis-)mount	30
standalone operation	30
Frequency settings	26
Fuse	
diplexer	10
frequency converter	13
replacement	21

H

H/L SWITCH	9
H/L Switch cable	16

I

IF connector outputs	14
Input powers	13
Instrument setup	15

L

LO IN	13
-------------	----

M

Maintenance	21
MEAS OUT	14
MEAS OUT LOW	9
Measurement	27
Measurement principle	23

P

PORT 1 / 2 / 3 / 4	7
Port Configuration	26
Power calibration	26
Power Coefficients	24
Power control cable	16
Power on	20
Power settings	26
Power supply connector	12
Preparing the analyzer for use	6

R

Rear panel	
diplexer	9
frequency converter	11
REF OUT	14
REF OUT LOW	9
Replacing fuses	21
Required Equipment	23
RF connection	17
RF connector inputs	13
RF IN	13
RF IN LOW / HIGH	9

S

Service re-calibration	31
Standby switch	12
Storing the instrument	21
System Configuration	23
System error correction	27

T

Test port	
analyzer	7
diplexer	9
Troubleshooting	28

U

Unpacking	14
-----------------	----

W

Waveguide flange	11
------------------------	----

Z

ZVA110-BU (measurement mode)	23
------------------------------------	----